







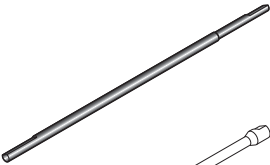

TECHNICAL INFORMATION

SUBJECT: Carburetor adjustment tool

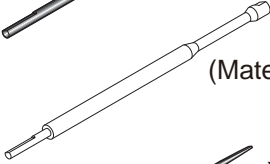
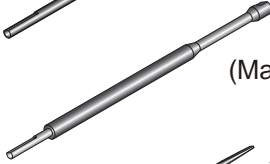
Number: Y2015-575
Issued: Aug. 31, 2015
Revised: May. 31, 2019

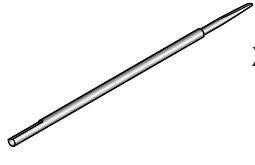
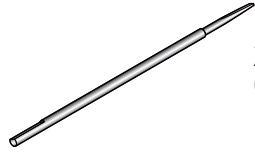
Material of D-shaped tool (L) is changed to increase durability.

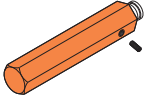
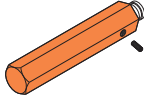
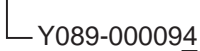
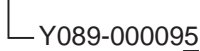
	Before change	After change
L-wrench (2.0 mm)	 X605-00010	 X605-00010 (Unchanged)
D-shaped tool (S)	 X645-00022	 X645-00022 (Unchanged)
D-shaped tool (L)	 X645-00031 (Material: stainless-steel)	 X645-00032 (Material: Carbon steel)
Driver (2.0 mm)	 X603-00060	 X603-00060 (Unchanged)
Driver (2.5 mm)	 X603-00050	 X603-00050 (Unchanged)
E-ring	 900700-00007	 900700-00007 (Unchanged)
Set screw	 91134-04010	 91134-04010 (Unchanged)
Carburetor adjustment tool kit	 Y089-000094	 Y089-000095

Carburetor adjustment tool kit Y089-000094 can be replaced with Y089-000095.

TECHNICAL INFORMATION

SUBJECT: Short type D-shaped tool (S) for adjusting carburetor

Number: Y2019-673
Issued: Sep. 30, 2019

Short type D-shaped tool (S) is introduced to ease carburetor adjustment for models which has narrow space around carburetor.

Service tool

Short type
D-shaped tool(S)

91159S

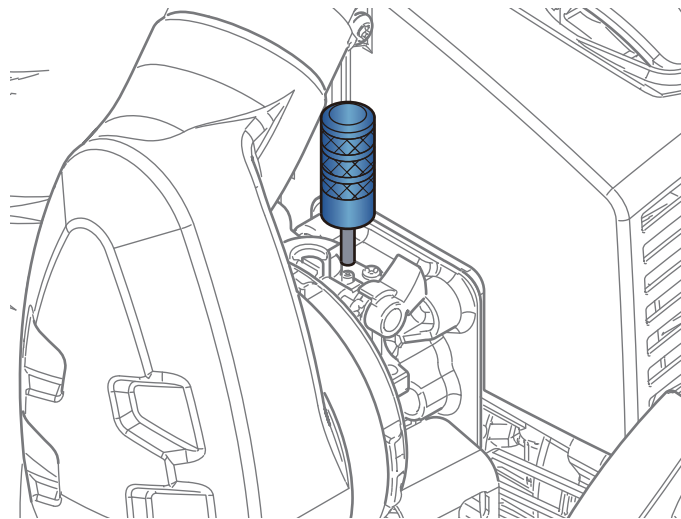
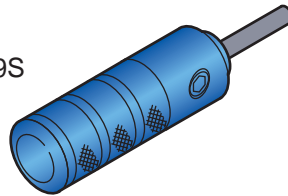

Suitable size: ECHO PB-8010